

INSTALLATION INSTRUCTIONS

LIEBHERR 954 EXCAVATOR

**Hammond Air Conditioning Ltd.
125 Samnah Cres.
Ingersoll, On.
N5C 3J7
1-800-267-2665
1-888-267-3745 (FAX)**

EVAPORATOR:

The evaporator/heater box mounts to the back wall of the cab just below the rear window.

1. Remove any materials and/or accessories from the rear wall of the cab to allow access for mounting the evaporator/blower assembly.
2. Using the hole template provided, mark the mounting holes on the back wall of the cab and drill out to 7/16" to accommodate the mounting hardware.
3. Mount the evaporator/blower assembly above the heater, as shown, with the hardware supplied and secure from the outside of the cab as shown. Use the spacers provided in the kit if necessary to stand off from the back wall. Make sure to seal the mounting holes with silicone or caulk before final assembly.
4. Route the drain tube out through an existing hole in the floor.



Evaporator assembly mounted in place.



Back of cab showing mounting arrangement for evaporator.

COMPRESSOR:

The compressor mounts to the engine on the lower left when facing down the engine toward the fan.

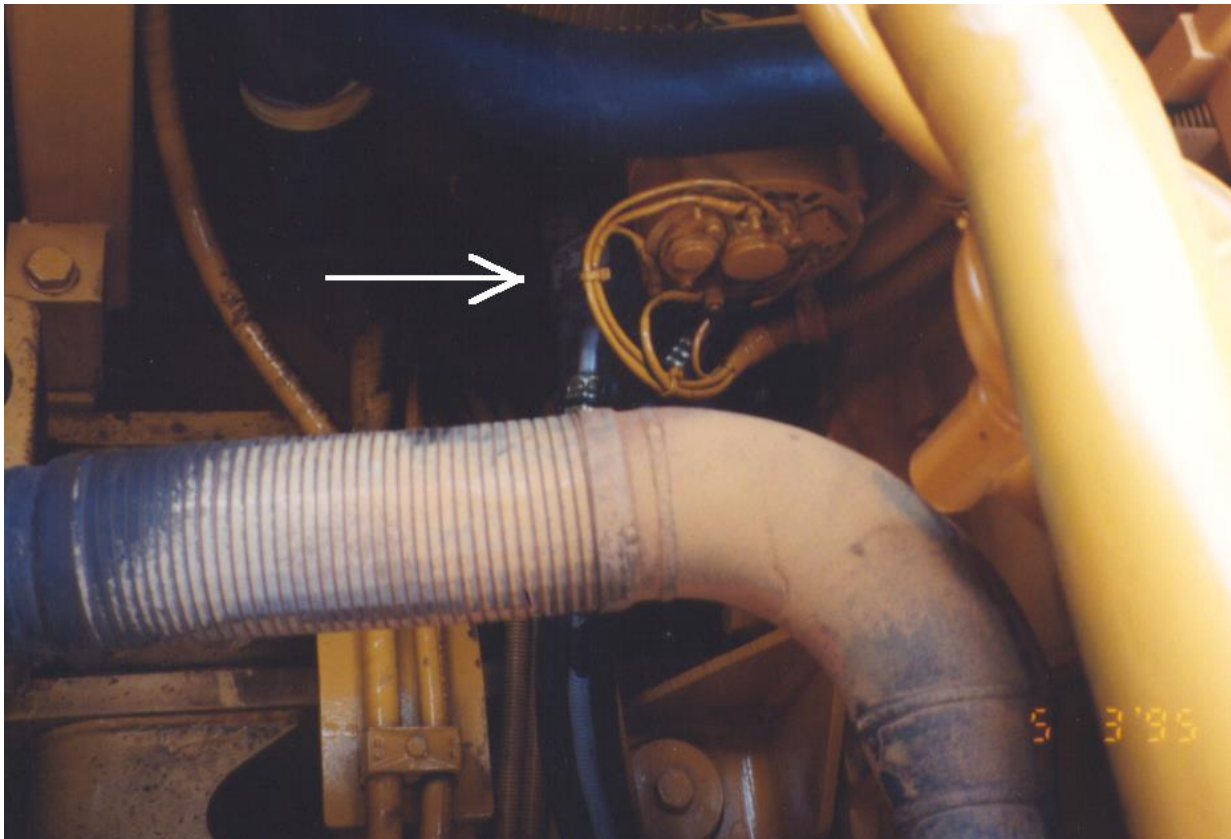

Location of compressor on engine, below alternator assembly.

1. The mount is bolted to the four pre-threaded holes on the lower left of the engine.
2. The add-on pulley for the crankshaft, provided in the kit, is mounted to the front of the crankshaft pulley using the hardware supplied.
3. Set the compressor onto the mount and check the alignment with the pulley supplied. If the alignment is accurate, tighten the bolts and mount the compressor into place.
4. Tighten the belt by using the integrated tightener slots on the mount assembly.

CONDENSER MOUNTING:

The condenser is configured for mounting on the intake side of the radiator.

1. Remove any screens or obstructions from in front of the radiator to allow for the mounting frame of the condenser.
2. Mount the condenser frame to the radiator frame so that the condenser can be hinged out for cleaning. Use the hardware supplied to mount the condenser frame.
3. The drier assembly is pre-mounted to the condenser frame with the hose connecting to the condenser outlet already connected in place.

HOSE RUNS:

5/16" Hose Drier to Evaporator:

The 5/16" hose runs from the drier forward under the cab of the machine. Route the hose through an existing hole in the floor and run up to the evaporator. Cut the hose to length and crimp on the straight male fitting. Connect the fitting to the expansion valve inlet fitting.

13/32" Hose Compressor to Condenser:

The 13/32" hose is run from the compressor to the condenser out of the engine compartment alongside the radiator and out to the condenser. The compressor fitting is already crimped in place on the hose and has the integral charging port. Connect the discharge side rotolock fitting making sure the white nylon seal is properly in place. The binary switch will be on this fitting. Connect the pre-crimped hose end fitting to the rotolock and run out to the condenser. Cut the hose to length and crimp on the 90o fitting supplied. Connect to the top fitting on the condenser.

1/2" Hose Compressor to Evaporator

The 1/2" hose runs from the compressor to the evaporator in the cab.

Connect the rotolock fitting on the suction side of the compressor. This fitting will have the 134a charging port on it instead of a 1/4" access port. The fitting at the compressor end of the hose has already been crimped in place. Connect to the rotolock fitting at the compressor and run out in front of the radiator with the 13/32" hose. Then route the hose forward under the cab with the 5/16" hose, from the drier, up to the suction fitting of the evaporator. Cut the hose to length and crimp on the straight male fitting and connect to the suction side of the expansion valve.

Hose-wrap exposed sections and any places the hoses may rub. Secure using cable ties and clamps where necessary. Use refrigerant oil on the O-rings at the sealing surfaces to ensure a proper seal.

WIRING:

The wiring for the air conditioning on the Liebherr excavator is easily installed and serviced because of its simplicity.

1. From the master power supply run a 10ga power wire to a 30Amp circuit breaker situated near it (within 24").
2. From the circuit breaker run a 10ga wire to a relay located in the cab near the evaporator unit. Run the power wire into the 24v relay onto post #30.
3. From an ignition live source (only on when the ignition key is turned on) run a control wire to the relay and connect to post #85. Ground post #86 to the cab frame.
4. Connect the power supply wire from the evaporator box to post #87 on the relay. Connect the ground wire from the box to a ground on the frame of the cab.
5. Run the clutch wire from the evaporator box to the compressor with the suction line. Connect to one post of the binary pressure switch. Connect the compressor wire to the other post.

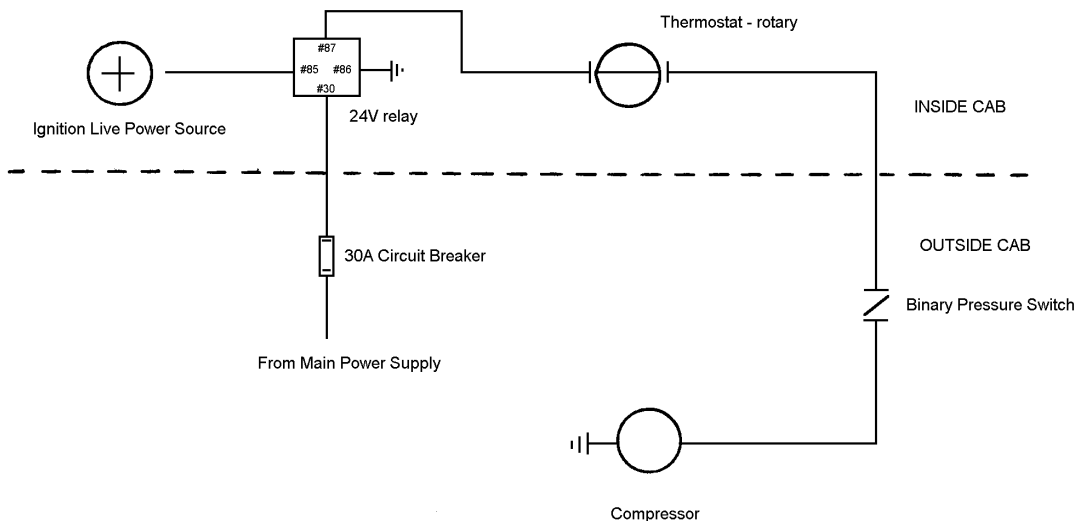

Refrigerant Flow Pattern in a Standard Air Conditioning System

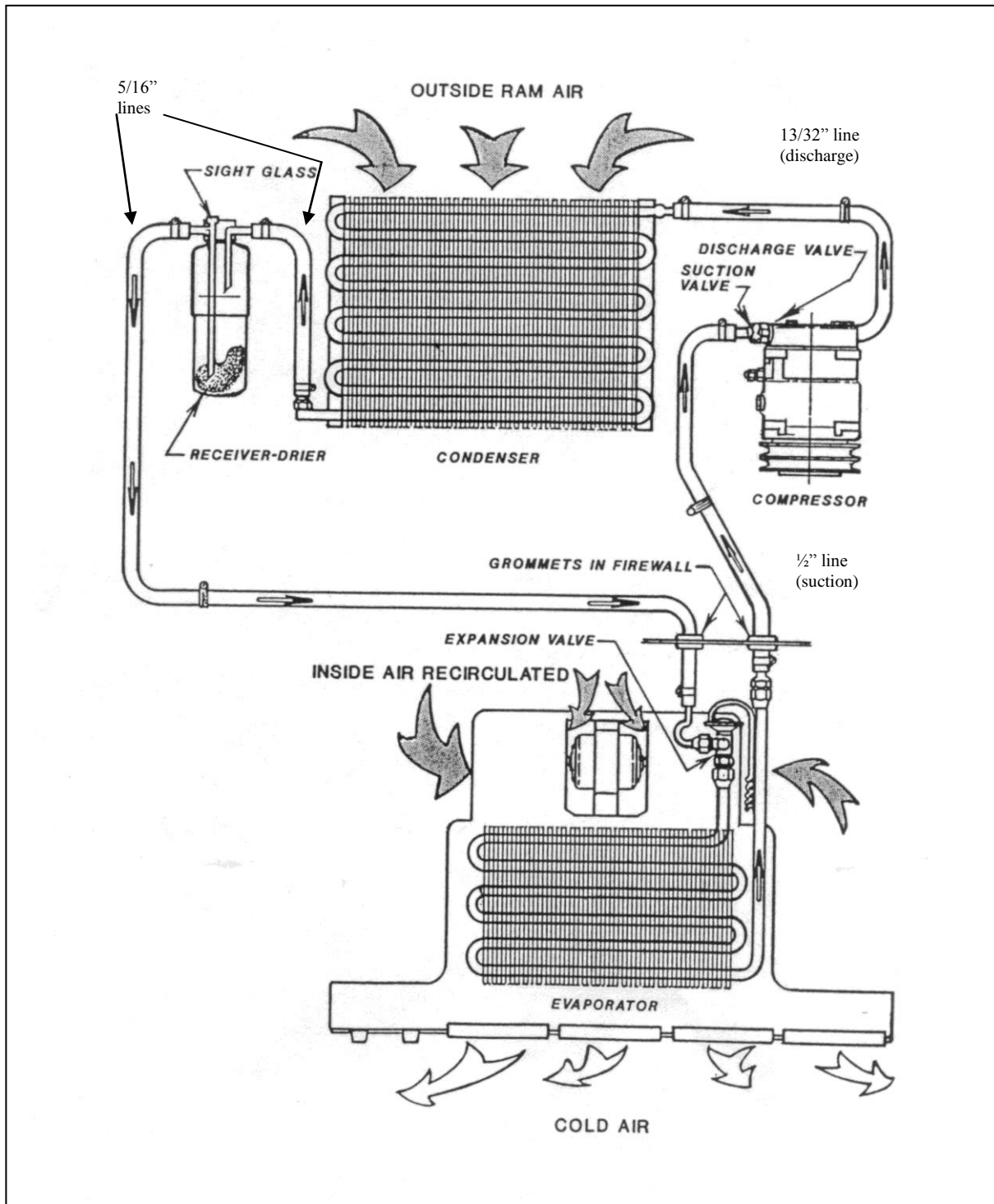

Thermostat Setting Procedures

- 1) Thermostat types
 - a) preset
 - b) adjustable

- a) A preset thermostat is adjusted to its specific cut in and cut out temperatures when manufactured and does not have a rotary adjustment for the operator.
- b) An adjustable or rotary thermostat has been manufactured to a predetermined cut in and cut out temperatures, but it is also operator adjustable to achieve the desired comfort level.

Both types of thermostats can have their factory settings adjusted by turning the setting screws on the body of the thermostat. One body type has the setting screws mounted externally and labeled for direction of rotation. The other body type requires the removal of the plastic end plate to expose the set screw.

- 2) Thermostat probe location: The location of the thermostat probe in an evaporator coil can be very important to achieve the maximum cooling potential of the coil while also preventing coil freeze-up. There is no set location for the thermostat probe to be put that will be optimum for all systems, but several rules of thumb may be followed:
 - a) Insert the probe in the coldest area of the evaporator coil.
 - b) Insert the probe from the top of the coil down, if possible.
 - c) Make sure that at least the last 3" of the thermostat probe are in the coil.

To find the most likely area where the coil is the coldest, consider these factors:

- 1) Direction of air flow through the coil.
 - 2) The coil area likely to have the lowest air flow.
 - 3) The inlet locations of the refrigerant into the coil.
 - 4) The inlet of the hotter outside air into the coil area.
-
- 1) Usually the coldest side of the evaporator coil will be the air outlet side. Often the thermostat probe can be inserted between the last and second last row of tubes.
 - 2) The lower air flow area of the evaporator coil in most systems tends to be near either end of the coil. These areas will be colder
 - 3) The area of the coil that the refrigerant inlet tube(s) occupy should be the coldest part of the coil.
 - 4) If the system is equipped with an outside air intake, where and how that air is brought into the evaporator area can have a large effect on the coil temperature. If all the outside air is piped into the evaporator in one area, that area will be considerably warmer in hot weather.

By looking at all these different factors, the area of an evaporator coil most likely to be the coldest can be determined.

Once the probe is inserted, the A/C system needs to be tested. Run the system to ensure that the thermostat is cycling the compressor off at the appropriate temperature. A core temperature ranging between 25° and 30° F should cause the thermostat to cycle off. The air temperature at the vent outlet closest to the evaporator coil should be between 38° F and 45° F when the compressor cycles off.

If the thermostat doesn't cycle off after a reasonable cool down period, and the air outlet temperature has dropped below 40° F, the cut in and cut out settings should be adjusted until the compressor is cycling on and off regularly. Let the system run for a decent time period (at least 15 min) and then check the evaporator coil for any signs of freezing.

Aeroquip E-Z Clip Assembly Instructions

Step 1. Cut the hose to proper length with an appropriate cutting tool. Aeroquip's hand held hose cutter has been specially designed for cutting all non-wire reinforced hose, such as GH-134 Multi-Refrigerant hose. Be sure the cut is made square to the hose length.

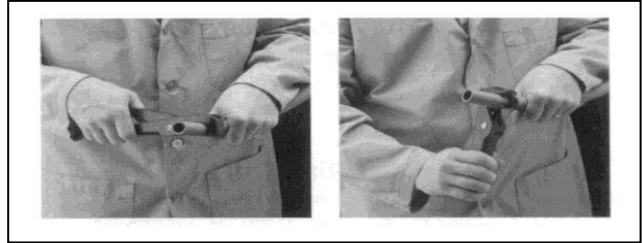

Step 2. Install two proper-sized clips onto the cut end of the hose. Orientation of the clips does not affect the performance of the connection. However, for ease of assembly, both clips should have the same orientation. NOTE: Failure to slide the clips over the hose at this time will require the clips to be stretched over the hose or fitting later. This may permanently damage the clip.

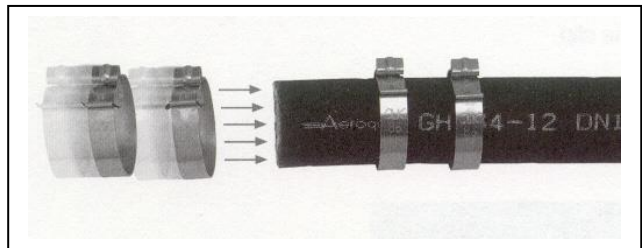

Step 3. Lubricate the nipple with a generous amount of the refrigeration or A/C system's compressor lubricating oil. This MUST be done to lower the force of nipple insertion.

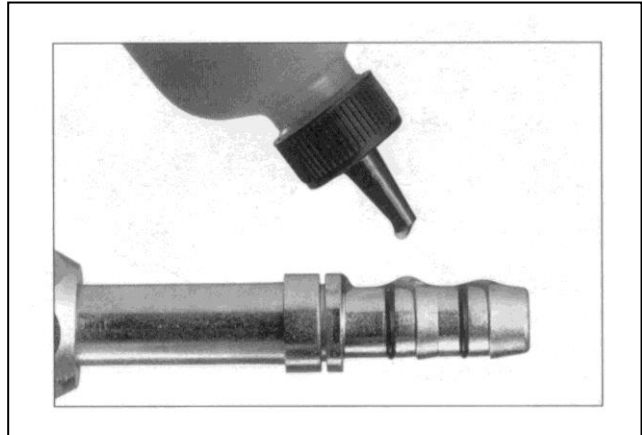

Step 4. Insert the nipple into the hose. To ensure that the nipple is fully inserted, check the gap between the cut end of the hose and the shoulder on the nipple. Care should be taken to avoid kinking or other damage to the hose during nipple insertion.

NOTE: Be sure to wipe excess oil from the nipple and hose.



Step 5. Snap the cage into the groove on the nipple. The arms should extend over the hose length. When the cage has been correctly installed in the cage groove, the cage will be able to rotate in the groove. This step **MUST** be performed to ensure:

1. The clips will be located over the O-rings on the nipple.
2. The connection will be compatible with the connection's pressure rating.

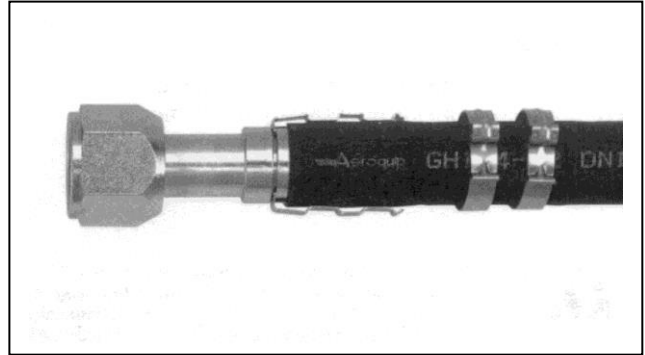

Step 6. Slide the clips over the cage arms and into the channels on each arm.



Step 7. Use the pliers to close the clips. The pliers should be positioned squarely on the clip connection points and should remain square during the closing of the clip.

NOTICE: E-Z Clip components should not be reused.

